

Data sheet | Item number: 2092-1103/000-5000

1-conductor female plug; Gripping plate; direct marking; 2.5 mm²; Pin spacing 5 mm; 3-pole; 2,50 mm²; light gray

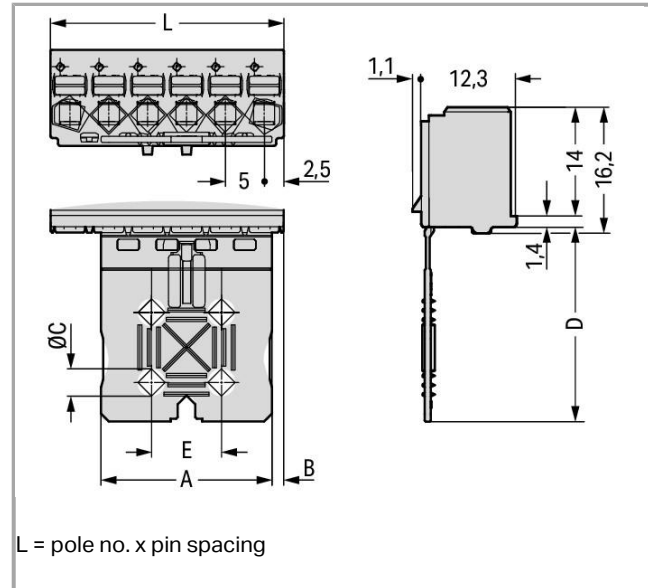

2092-1103_000-5000



RoHS Compliant

Color:

Item description

- Universal connection for all conductor types
- Simple, push-in termination of solid and ferruled conductors
- Easy-to-use design does not require specialty tools
- Ability to wire while mated or unmated
- Test port parallel to conductor entry – touch contact
- Integrated locking latches prevent accidental disconnection

Safety information 1:

The **picoMAX® pluggable connection system** is designed without breaking capacity for compliance with DIN EN 61984. When used as intended, MCS Connectors shall not be connected/disconnected when live or under load. The circuit design should ensure header pins, which can be touched, are not live when unmated.

Data

Electrical data

Ratings per IEC/EN 60664-1

Rated voltage (III / 3)	250 V
Rated impulse voltage (III / 3)	4 kV
Rated voltage (III / 2)	320 V
Rated impulse voltage (III / 2)	4 kV
Rated voltage (II / 2)	630 V
Rated impulse voltage (II / 2)	4 kV
Rated current	16 A

Approvals per UL 1059

Rated voltage UL (Use Group B)	300 V
Rated current UL (Use Group B)	15 A
Rated voltage UL (Use Group D)	300 V

Connection data

Connection technology	Push-in CAGE CLAMP®
Actuation type	Push-button
Solid conductor	0.2 2.5 mm ² / 24 12 AWG
Fine-stranded conductor	0.2 2.5 mm ² / 24 12 AWG
Fine-stranded conductor with ferrule with plastic collar	0.25 1.5 mm ²
Fine-stranded conductor with ferrule without plastic collar	0.25 2.5 mm ²
Strip length	9 10 mm / 0.35 0.39 inch
Total number of connection points	3
Total number of potentials	3
Number of connection types	1
Number of levels	1
No. of poles	3

Geometrical Data

Pin spacing	5 mm / 0.197 inch
Width	15 mm / 0.591 inch
Height	35.4 mm / 1.394 inch
Depth	13.4 mm / 0.528 inch

Mechanical data

Design	With gripping plate
--------	---------------------

Plug connection

Contact type (pluggable connector)	Female connector/socket
Connector connection type	for conductors
Mismating protection	No

Material Data

Color	light gray
Material group	I
Insulating material	Polyphthalamide (PPA GF)
Flammability class per UL94	V0
Clamping spring material	Chrome nickel spring steel (CrNi)
Contact material	Electrolytic copper (E _{Cu})
Contact plating	tin-plated
Fire load	0.072 MJ
Weight	3 g

Environmental Requirements



Limit temperature range	-60 +100 °C
-------------------------	-------------

Commercial data

Country of origin	DE
GTIN	4050821353805
Customs Tariff No.	85366990990



Approvals / Certificates

Radio-Approvals

Logo	Approval	Additional Approval Text	Certificate name
	CB DEKRA Certification B.V.	IEC 61984	NL-49737
	CSA DEKRA Certification B.V.	C22.2	2362521
	KEMA/KEUR DEKRA Certification B.V.	IEC 61984	71- 102261

Country specific Approvals

Certificate

Logo	Approval	Additional Approval Text	name
	CB DEKRA Certification B.V.	IEC 61984	NL-49737
	CSA DEKRA Certification B.V.	C22.2	2362521
	KEMA/KEUR DEKRA Certification B.V.	IEC 61984	71- 102261

Other Approvals

Logo	Approval	Additional Approval Text	Certificate name
	cURus Underwriters Laboratories Inc.	UL 1059	E45172

UL-Approvals

Logo	Approval	Additional Approval Text	Certificate name
	cURus Underwriters Laboratories Inc.	UL 1059	E45172

Compatible products

check

	Item no.: 735-500 Test pin; 1 mm Ø; with solder connection for test wire	735-500
--	--	---------

tools

	Item no.: 210-719 Operating tool; Blade: 2.5 x 0.4 mm; with a partially insulated shaft	210-719
--	---	---------

Downloads

Documentation

Additional Information

Technical explanations	Apr 3, 2019	pdf 3.6 MB	Download
------------------------	-------------	---------------	----------



Product family

picoMAX

Show all products from the family

Subject to changes.
